

## 4. INSTALLATION OF DATALOGGER (OPTIONAL)

- 1 Open the COM port cover plate, assemble the datalogger and USB port together as shown in the figure, and tighten the datalogger.
- 2 The datalogger can support Wifi or 4G communication. Refer to the datalogger installation guide for detailed operation.

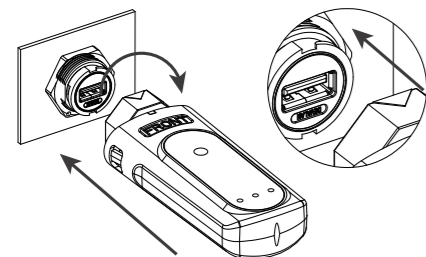

## 5. ANTI-REFLOW (OPTIONAL)

Install the current sensor on the L-wire of the power grid, ensure the direction of the current sensor from the L-wire of the power grid to the home, insert the terminal into the CT port of the inverter and tighten the terminal. Connect the black wire with "-" of the CT connector, while connect the black and white wire with "+".

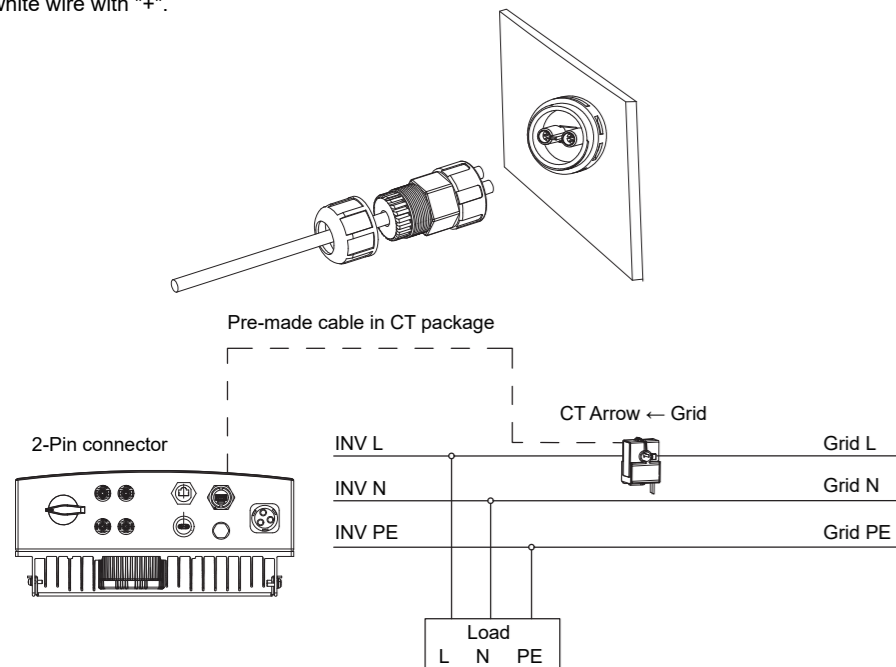

## 6. DRM CONTROL(OPTIONAL)

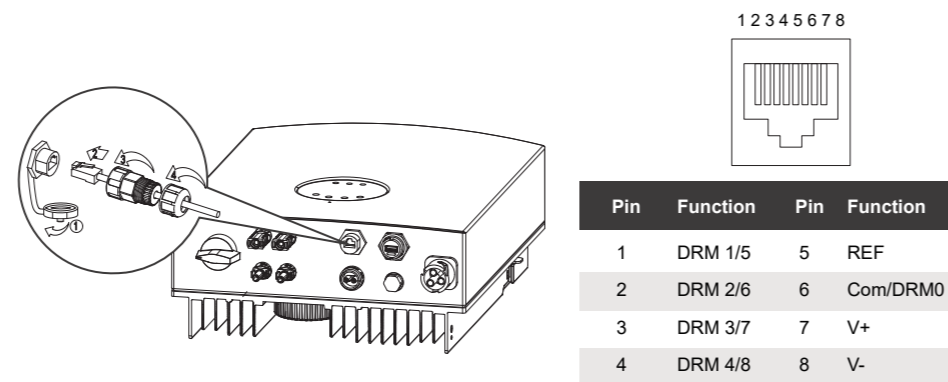

## 7. INSPECTION BEFORE OPERATION

No.	Inspection items
1	The inverter shall be installed correctly, firmly and reliably
2	Cables shall be reasonably arranged and well protected, without damage
3	The datalogger shall be installed correctly, firmly and reliably
4	The safety signs and warning labels on the inverter are not blocked or damaged
5	" DC SWITCH "and all switches connected to the inverter are" OFF "
6	The AC output cable, DC input cable and grounding wire are connected correctly, firmly and reliably
7	Unused terminals and interfaces are protected with waterproof covers
8	Reasonable selection of AC circuit breaker
9	Reasonable installation space, clean and tidy environment, no construction remains

## 8. POWER ON THE SYSTEM

- 1 At the AC switch between the inverter and the power grid, measure the voltage at the power grid side with a multimeter to confirm that the voltage of the power grid is within the allowable range of the inverter operating voltage.
- 2 Close the AC switch.
- 3 Set "DC SWITCH" on inverter to "ON".
- 4 Observe the inverter LED indicator and check the inverter operating status.

The registered account and password can be logged in at the same time on the APP and the website, or on multiple devices. This is a quick installation manual. If you do not know the specific operation, please contact our technical support.

# AUXSOL

## QUICK INSTALLATION MANUAL

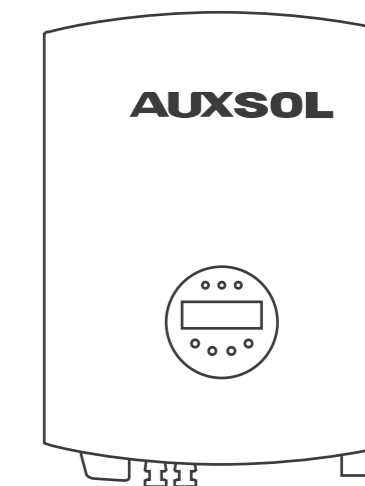

**ASN-(3.6 ~ 6)SL-PLUS**

# AUXSOL

WIN GREEN FUTURE TOGETHER

Ningbo AUX Solar Technology Co., Ltd.

No.17 Fenglin Road, Cicheng Town,  
Jiangbei District, Ningbo City, Zhejiang Province, China

✉ info@auxsol.com

🌐 www.auxsol.com

☎ +86 0574-8765 2201

Before opening the inverter package, check the outer package for damage. Open the package and check the inverter for damage of exterior or missing accessories.

The attachments are placed as follows:

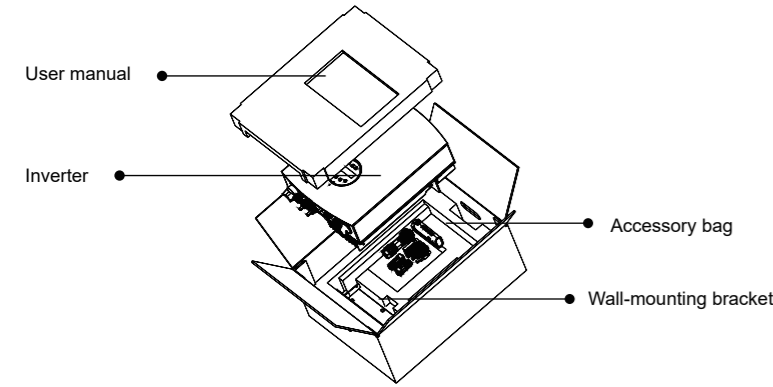

No.	Description	Model	Unit	QTY	Remark
1	Inverter	ASN-3.6~6SL-PLUS	pcs	1	
2	User manual	ASN-3.6~6SL-PLUS	pcs	1	
3	Quick installation manual	ASN-3.6~6SL-PLUS	pcs	1	
4	PV terminals (+, -)		set	2	black
5	Wall-mounting bracket	ASN-3.6~6SL-PLUS	pcs	1	
6	Self tapping screws+bolt expansion	M6*50+Φ10*45	pcs	3	
7	Combination screws	M4×12	pcs	2	
8	Datalogger		pcs	1	optional
9	Inspection report	ASN-3.6~6SL-PLUS	pcs	1	
10	AC wiring terminal		pcs	1	black
11	Current transformer		pcs	1	optional
12	CT connector (s)		pcs	1	optional
13	DRM connector		pcs	1	optional

## 1. INSTRUCTIONS FOR USER

- The contents of this document will be updated irregularly due to product version upgrading or other reasons. This document is only an installation guide and does not replace the user manual or the safety instructions on the product.
- All equipment operations must be performed by professional electrical technicians.
- Please read the user manual carefully for product information and safety precautions before installing the equipment. Equipment damage due to storage, handling, installation and use of equipment not in accordance with this document and the user manual is not covered by the equipment warranty.
- Insulating tools must be used when installing equipment. For personal safety, please wear personal protective equipment.

## 2. INSTALLATION OF INVERTER

If the installation space does not meet the requirements, the inverter may be derated.

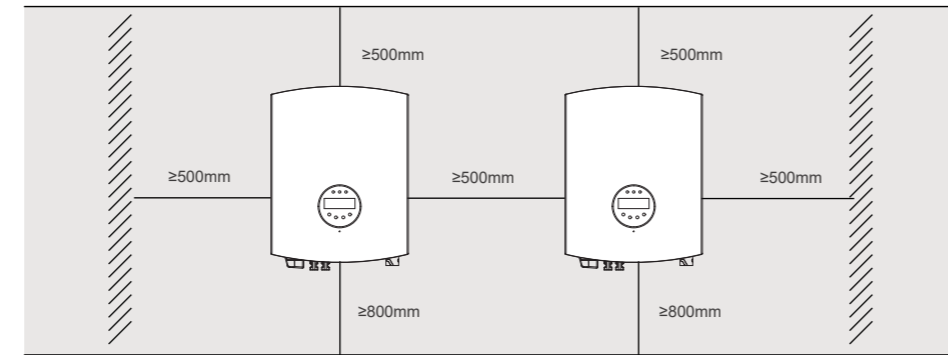

Fig. 2.0 Installation clearance of inverter

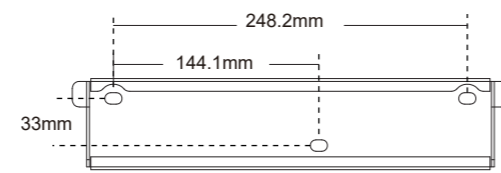

Fig. 2.1 Wall-mounting bracket

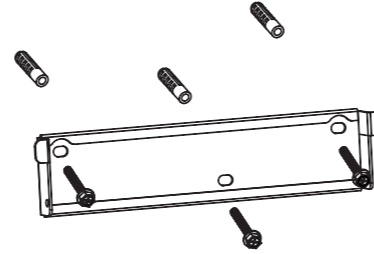

Fig. 2.2 Wall mounted inverter

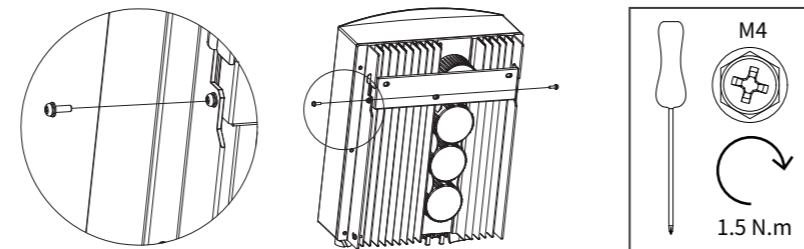

Fig. 2.3 Wall mounted inverter

- Select the mounting height of the support and mark the mounting holes according to Figure 2.2. For brick walls, the holes must be drilled for expansion bolts.
- Confirm that the installation hole position is correctly marked, the support is horizontal, punch holes at the marked position, and drive the expansion pipe into the installation hole.
- Lift the inverter and align the rear bracket of the inverter with the convex of the mounting bracket. Hang the inverter on the mounting bracket and make sure it is secure (see Figure 2.3).
- Lock the inverter in the mounting bracket using the M5 screws of the accessory.

## 3. ELECTRICAL CONNECTION

### 3.1 Preparation before installation

- Before making electrical connections, make sure that the inverter's "DC SWITCH" and all switches connected to the inverter are in the "OFF" position, otherwise the high voltage of the inverter may cause electrical shock.
- In order to ensure that the inverter and the grid can be safely disconnected in case of abnormal conditions, please connect the AC switch on the AC side of the inverter. Please select proper AC switch according to local industry standards and regulations.
- Electrical connections shall comply with the regulations of the country where the equipment is located.

### 3.2 DC input side connection

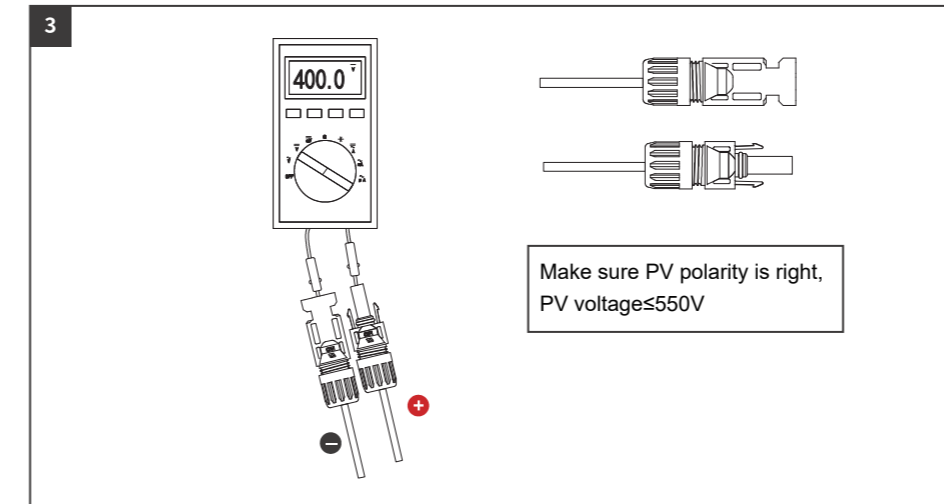
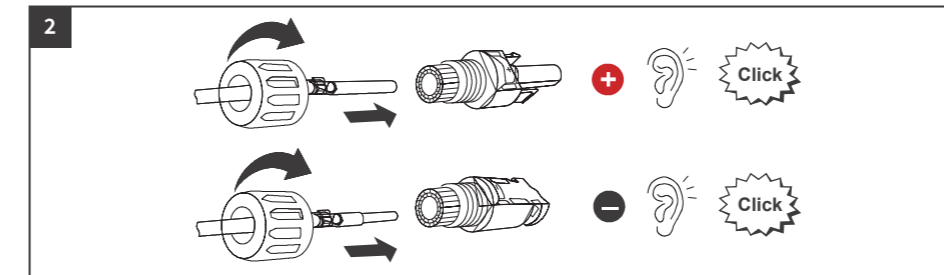
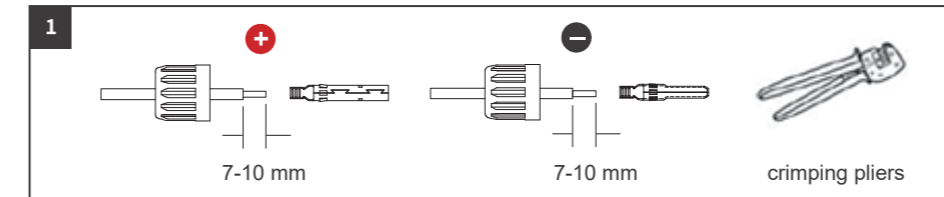

### 3.3 AC output side connection

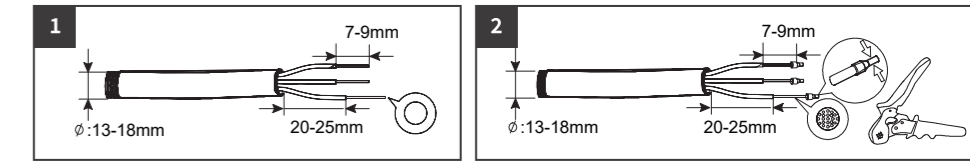

Model	Wire gauge	Conductor cross-section
ASN-3.6SL-PLUS	12AWG	3.33mm <sup>2</sup>
ASN-(4-6)SL-PLUS	10AWG	5.26mm <sup>2</sup>

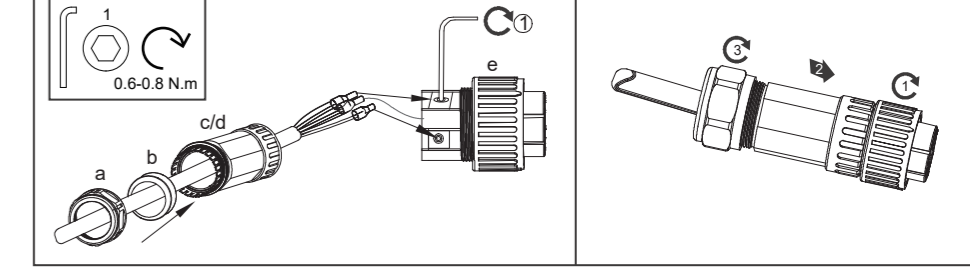
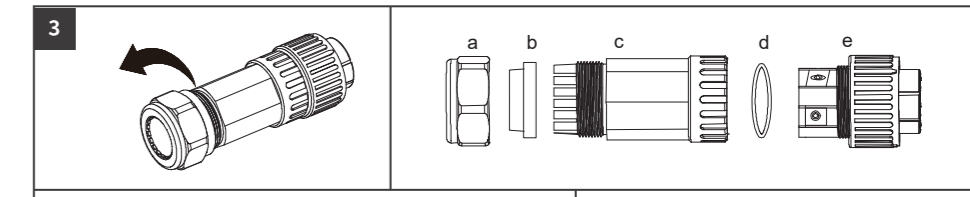

### 3.4 Ground connection

